

# janvier 2011

WWW.  
HORLOGERIE-SUISSE  
COM

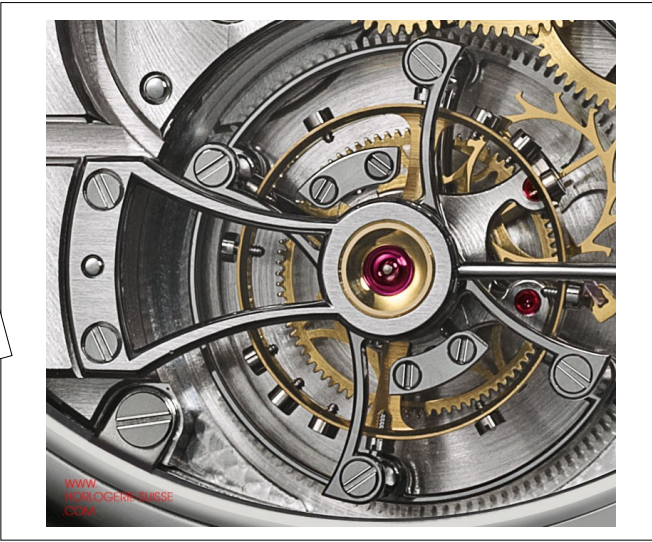
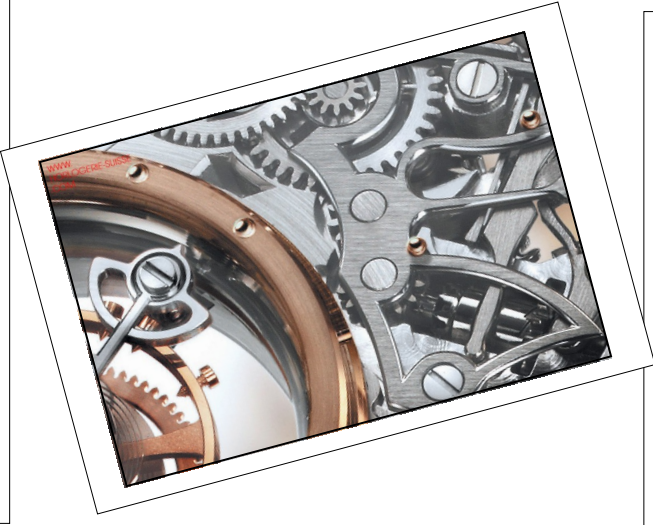
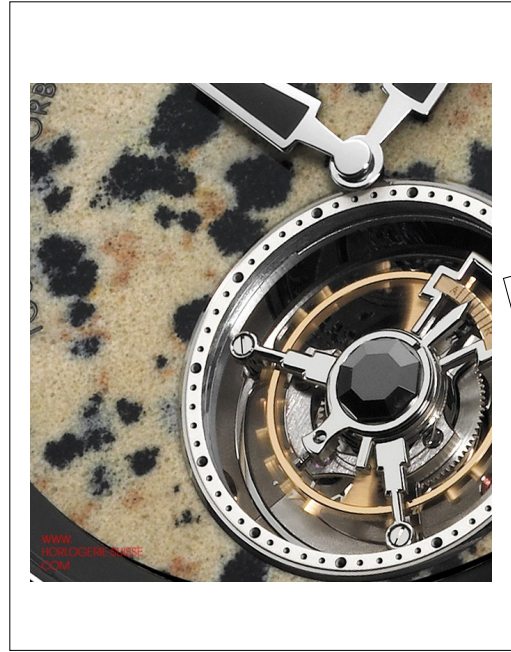

lun.	mar.	mer.	jeu.	ven.	sam.	dim.
					1	2
3	4	5	6	7	8	9
10	11	12	13	14	15	16 Geneva Time Exhibition
17 SIHH / GTE	18 SIHH / GTE	19 SIHH / GTE	20 SIHH / GTE	21 SIHH / GTE	22	23
24	25	26	27	28	29	30
31						

# février 2011

WWW.  
HORLOGERIE-SUISSE  
COM

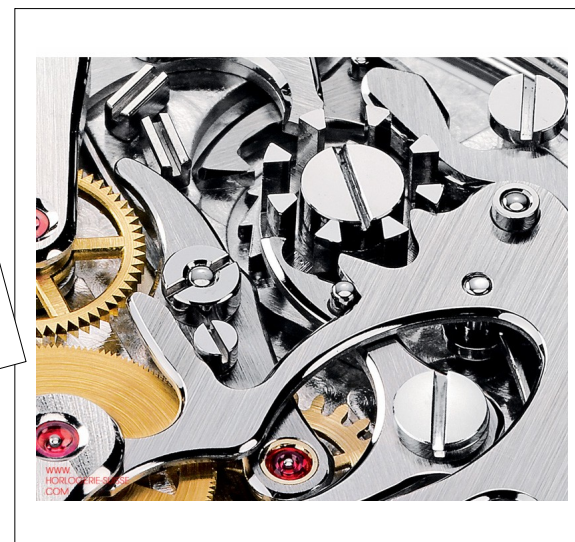
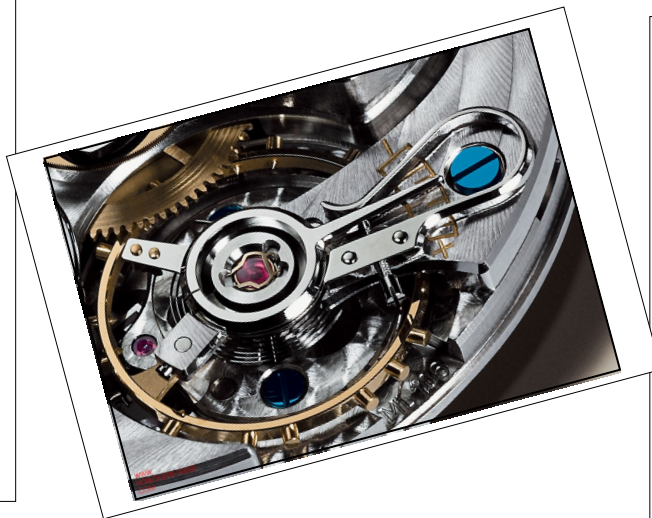

<b>lun.</b>	<b>mar.</b>	<b>mer.</b>	<b>jeu.</b>	<b>ven.</b>	<b>sam.</b>	<b>dim.</b>
	<b>1</b>	<b>2</b>	<b>3</b>	<b>4</b>	<b>5</b>	<b>6</b>
<b>7</b>	<b>8</b>	<b>9</b>	<b>10</b>	<b>11</b>	<b>12</b>	<b>13</b>
<b>14</b>	<b>15</b>	<b>16</b>	<b>17</b>	<b>18</b>	<b>19</b>	<b>20</b>
<b>21</b>	<b>22</b>	<b>23</b>	<b>24</b>	<b>25</b>	<b>26</b>	<b>27</b>
<b>28</b>						



# mars 2011

WWW.  
HORLOGERIE-SUISSE  
COM

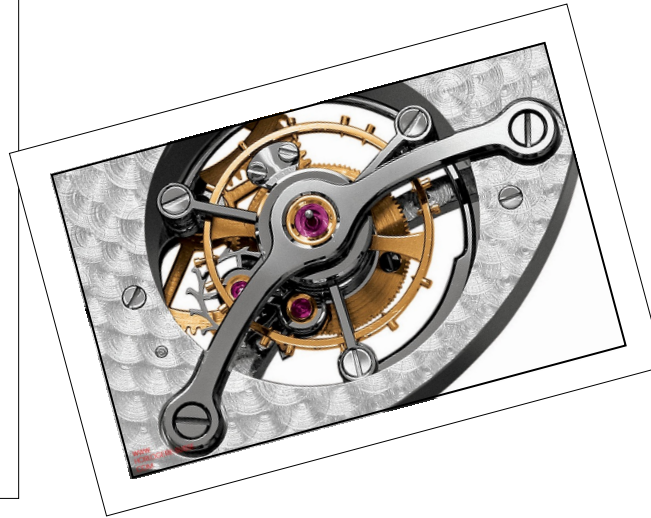

lun.	mar.	mer.	jeu.	ven.	sam.	dim.
	1	2	3	4	5	6
7	8	9	10	11	12	13
14	15	16	17	18	19	20
21	22	23	24 BASELWORLD	25 BASELWORLD	26 BASELWORLD	27 BASELWORLD
28 BASELWORLD	29 BASELWORLD	30 BASELWORLD	31 BASELWORLD			

# avril 2011

WWW.  
HORLOGERIE-SUISSE  
COM

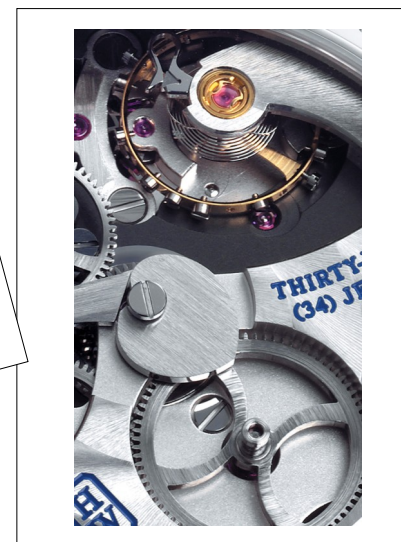
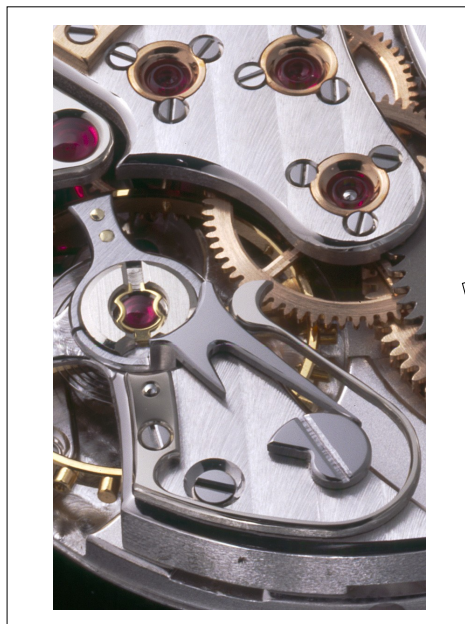

<b>lun.</b>	<b>mar.</b>	<b>mer.</b>	<b>jeu.</b>	<b>ven.</b>	<b>sam.</b>	<b>dim.</b>
				<b>1</b>	<b>2</b>	<b>3</b>
<b>4</b>	<b>5</b>	<b>6</b>	<b>7</b>	<b>8</b>	<b>9</b>	<b>10</b>
<b>11</b>	<b>12</b>	<b>13</b>	<b>14</b>	<b>15</b>	<b>16</b>	<b>17</b>
<b>18</b>	<b>19</b>	<b>20</b>	<b>21</b>	<b>22</b>	<b>23</b>	<b>24</b>
<b>25</b>	<b>26</b>	<b>27</b>	<b>28</b>	<b>29</b>	<b>30</b>	

# mai 2011

WWW.  
HORLOGERIE-SUISSE  
COM

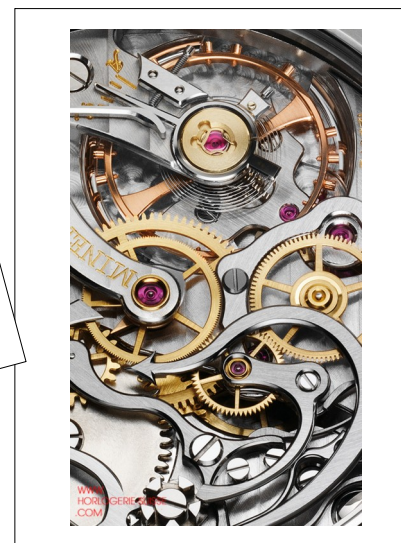
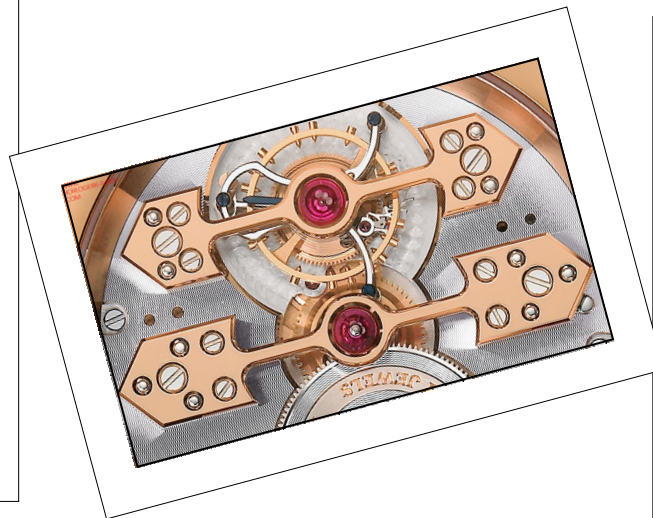

lun.	mar.	mer.	jeu.	ven.	sam.	dim.
						1
2	3	4	5	6	7	8
9	10	11	12	13	14	15
16	17	18	19	20	21	22
23	24 EPHJ-EPMT	25 EPHJ-EPMT	26 EPHJ-EPMT	27 EPHJ-EPMT	28	29
30	31					

# juin 2011

WWW.  
HORLOGERIE-SUISSE  
COM

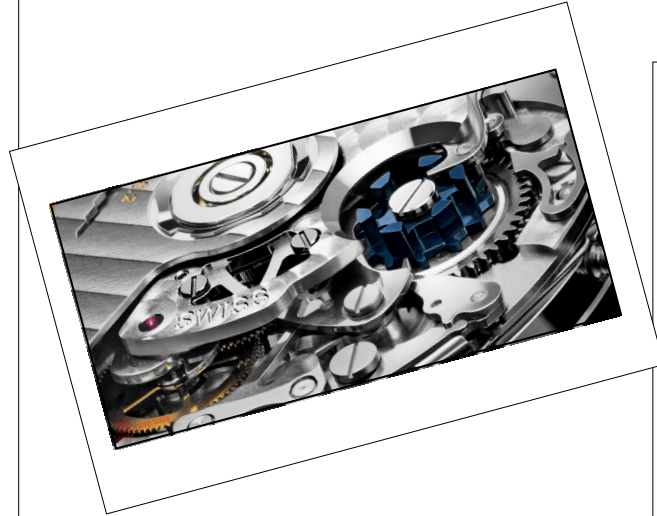

<b>lun.</b>	<b>mar.</b>	<b>mer.</b>	<b>jeu.</b>	<b>ven.</b>	<b>sam.</b>	<b>dim.</b>
		1	2	3	4	5
6	7	8	9	10	11	12
13	14	15	16	17	18	19
20	21	22	23	24	25	26
27	28	29	30			



# juillet 2011

WWW.  
HORLOGERIE-SUISSE  
COM

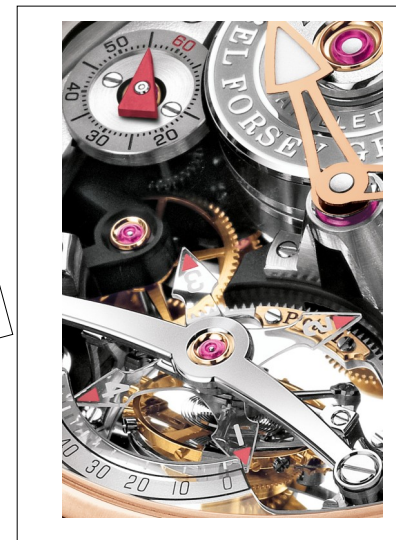
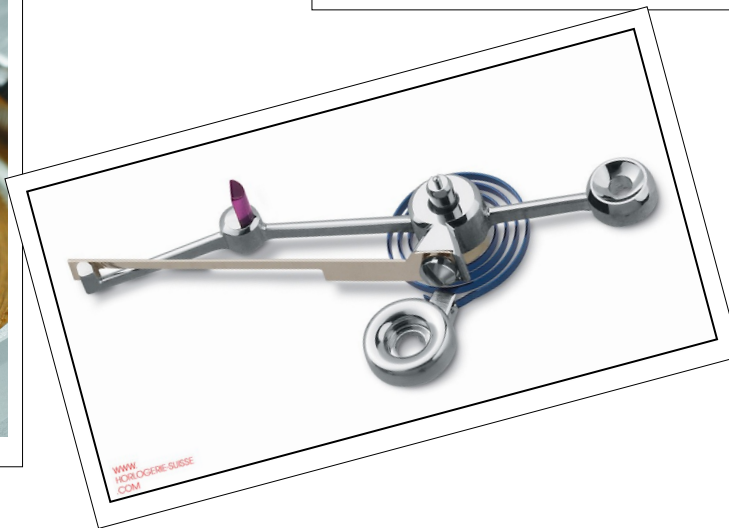

lun.	mar.	mer.	jeu.	ven.	sam.	dim.
				1	2	3
4	5	6	7	8	9	10
11	12	13	14	15	16	17
18	19	20	21	22	23	24
25	26	27	28	29	30	31

# août 2011

WWW.  
HORLOGERIE-SUISSE  
COM

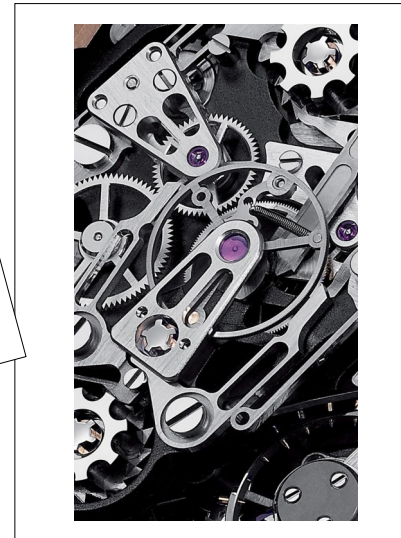
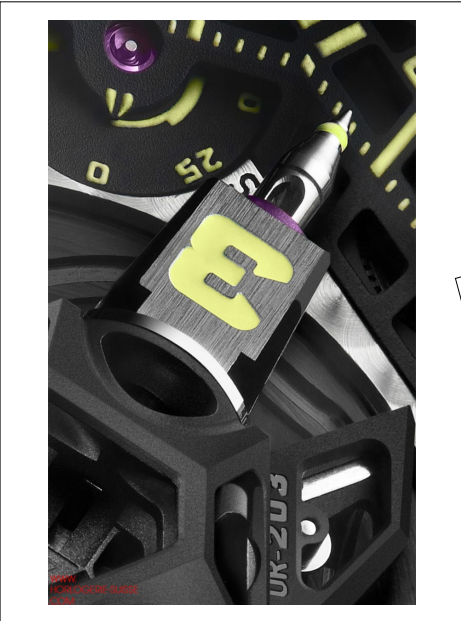

<b>lun.</b>	<b>mar.</b>	<b>mer.</b>	<b>jeu.</b>	<b>ven.</b>	<b>sam.</b>	<b>dim.</b>
1	2	3	4	5	6	7
8	9	10	11	12	13	14
15	16	17	18	19	20	21
22	23	24	25	26	27 Antik Uhrenbörse	28 Antik Uhrenbörse
29	30	31				



# septembre 2011

WWW.  
HORLOGERIE-SUISSE  
COM

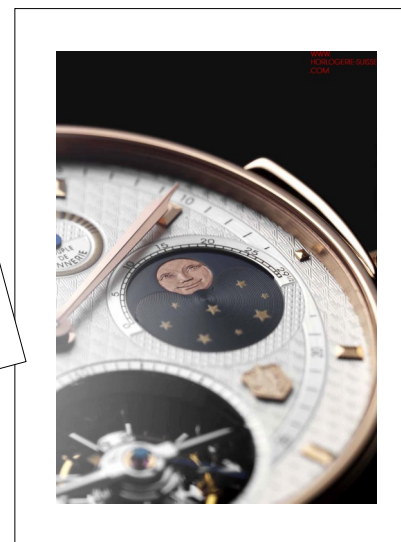
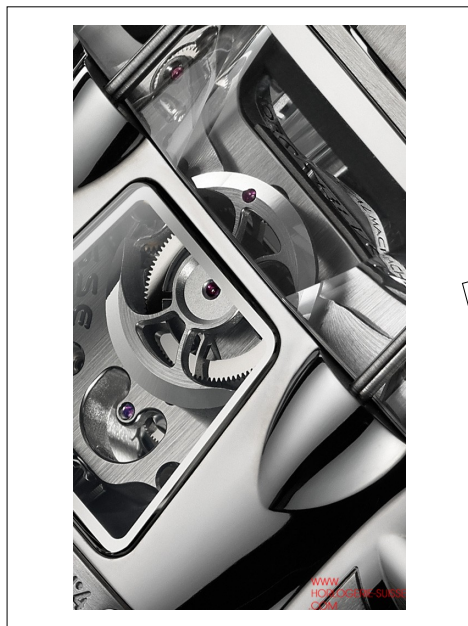

lun.	mar.	mer.	jeu.	ven.	sam.	dim.
			1	2	3	4
5	6	7 10ans Horlogerie- Suisse.Com	8	9	10	11
12	13	14	15	16	17	18
19	20	21	22	23	24	25
26	27	28	29	30		



# octobre 2011

WWW.  
HORLOGERIE-SUISSE  
COM



lun.	mar.	mer.	jeu.	ven.	sam.	dim.
					1	2
3	4	5	6	7	8	9
10	11	12	13	14	15	16
17	18	19	20	21	22	23
24	25	26	27	28	29	30
31						

# novembre 2011

WWW.  
HORLOGERIE-SUISSE  
COM

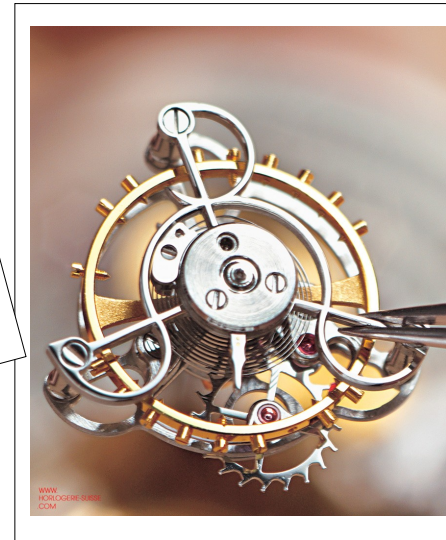

<b>lun.</b>	<b>mar.</b>	<b>mer.</b>	<b>jeu.</b>	<b>ven.</b>	<b>sam.</b>	<b>dim.</b>
	<b>1</b>	<b>2</b>	<b>3</b>	<b>4</b>	<b>5</b>	<b>6</b> Horlo'Troc (Morteau) Bourse de la Chaux-de-Fonds
<b>7</b>	<b>8</b>	<b>9</b>	<b>10</b>	<b>11</b>	<b>12</b>	<b>13</b>
<b>14</b>	<b>15</b>	<b>16</b>	<b>17</b>	<b>18</b>	<b>19</b>	<b>20</b>
<b>21</b>	<b>22</b>	<b>23</b>	<b>24</b>	<b>25</b> BELLES MONTRES (Paris)	<b>26</b> BELLES MONTRES (Paris)	<b>27</b> BELLES MONTRES (Paris)
<b>28</b>	<b>29</b>	<b>30</b>				

# décembre 2011

WWW.  
HORLOGERIE-SUISSE  
COM



<b>lun.</b>	<b>mar.</b>	<b>mer.</b>	<b>jeu.</b>	<b>ven.</b>	<b>sam.</b>	<b>dim.</b>
			1	2	3	4
5	6	7	8	9	10	11
12	13	14	15	16	17	18
19	20	21	22	23	24	25
26	27	28	29	30	31	